

**MEGA
BLOKS**

NEO SHIFTERS™

The Power² Change™

6303

6+

50 



DELTA TEK™



WWW.NEOSHIFTERS.COM

Delta::Tek™ - formed from Geological Research Satellite that scanned planets, mapping land masses and analyzing geological makeup, finding potential resource-rich locations.

Delta::Tek™ : Satélite de investigación geológico, diseñado para la exploración planetaria, la cartografía y el análisis geológico, lo que le permite descubrir fuentes de recursos.

Delta::Tek™ tire son origine d'un satellite de recherche géologique qui scannait les planètes, analyse les masses continentales et la composition géologique, en localisant les endroits potentiellement riches en ressources énergétiques.

Delta::Tek™ besteht aus einem geologischen Forschungssatelliten, der Planeten absucht, Landmassen kartographiert und Gestein analysiert, um potenziell reichhaltige Ressourcen ausfindig zu machen.

Delta::Tek™ is ontstaan uit een geologische onderzoekssatelliet die planeten scant, grondgebieden in kaart brengt en gesteente analyseert om lokaties te vinden die rijk aan natuurlijke rijkdommen zijn.

Delta::Tek™: formato da un satellite di ricerca geologica utilizzato per la scansione planetaria, il mapping della massa terrestre e l'analisi della struttura geologica e finalizzato alla ricerca di potenziali risorse energetiche.

Delta::Tek™ - formado a partir do Satélite de Investigaçao Geológica que analisava planetas, cartografando as massas terrestres e analisando a estrutura geológica, com vista a encontrar fontes de recursos.



TM

- Crystal Pulse Unit - emits an invisible percussive pulse that temporarily stuns Neo Shifters (friend and foe) in the blast radius.
- Unidad de impulsos Crystal: emite una serie de impulsos invisibles que aturden temporalmente a los Neo Shifters (amigos o enemigos) que se encuentren en su radio de acción.
- L'unité d'impulsion Crystal diffuse une impulsion par percussion invisible qui étourdit temporairement les Neo Shifters (amis et ennemis) situés dans le même rayon.
- Die Kristallpulseinheit sendet einen unsichtbaren Stoßpuls aus, der alle Neo Shifters (Verbündete und Gegner) im Umkreis vorübergehend betäubt.
- Crystal Pulse Unit stoot een onzichtbare, pulserende straal uit die vriendelijke en vijandige Neo Shifters in de omgeving van de straal tijdelijk verlamt.
- Unità a impulsi di cristallo: emette impulsi a percussione in grado di stordire momentaneamente i Neo Shifter (nemici o alleati) presenti nel suo raggio di azione.
- Unidade de Impulsos de Cristal - emite um impulso de percussão invisível que atordoa temporariamente os Neo Shifters (amigos e inimigos) dentro do seu raio de ação.



HYDRAX™

Hydrax™ Energy Level
 Nivel de energia Hydrax™
 Niveau d'énergie Hydrax™
 Hydrax™-Energiegrad
 Hydrax™ Krachtniveau
 Livello Energia Hydrax™
 Nivel de energia do Hydrax™



SKILL

Skill
 Técnica
 Technique
 Geschicklichkeit
 Bekwaamheid
 Specialita
 Habilidade



WEAPON

Weapon
 Arma
 Arme
 Waffe
 Wapen
 Arma
 Arma



DEFENSE

Defense
 Defensa
 Défense
 Verteidigung
 Verdediging
 Difesa
 Defesa

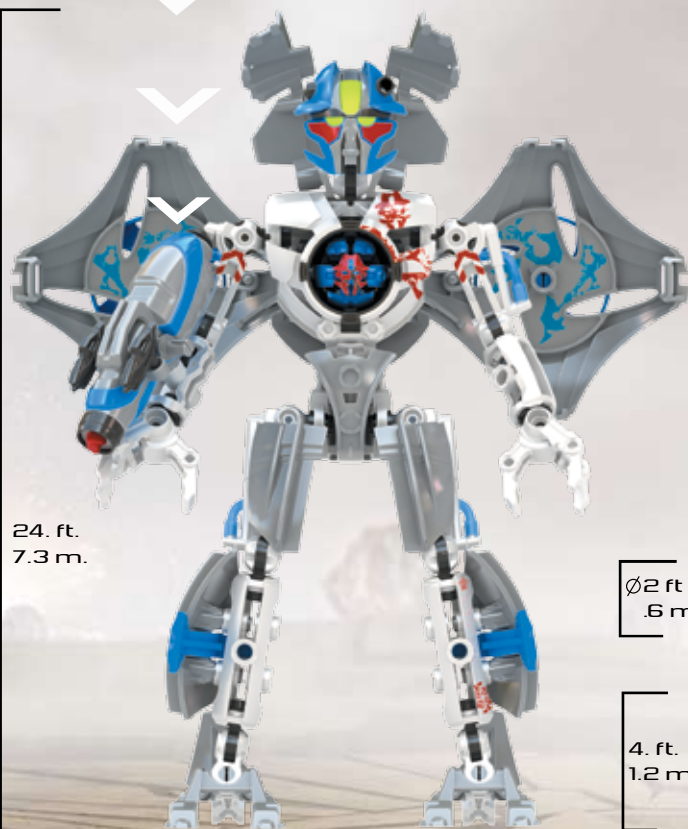

24. ft.
7.3 m.

Ø2 ft.
.6 m.



4. ft.
1.2 m.



6. ft.
1.8 m.

Ø11.3 ft.
3.4 m.

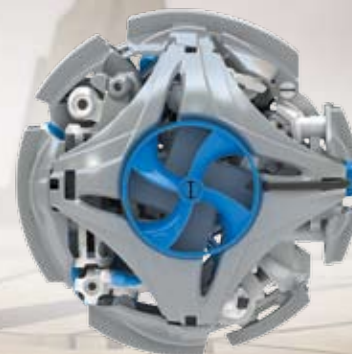

- Emulation Force Field - can cloak his structural makeup to make himself appear as a geological structure on enemy targeting scans.
- Campo de emulación de fuerza: puede transformar su composición exterior en cualquier estructura geológica para pasar desapercibido a los instrumentos de detección enemigos.
- Le champ de force d'émulation peut camoufler sa composition structurelle pour prendre la forme d'une structure géologique sur les systèmes de visée ennemis.
- Das Emulationskraftfeld kann sich so tarnen, das es auf den gegnerischen Radar systemen als Gesteinsformation erscheint.
- Emulation Force Field kan zich zo vermommen dat hij als gesteente op vijandelijke scans verschijnt.
- Campo di forza di emulazione: si tratta di una struttura che inganna i sistemi di individuazione del target nemici, facendola apparire come una massa geologica innocua.
- Campo de Força Camaleónico - disfarça a sua composição estrutural para surgir como uma formação geológica nos sensores inimigos.

BUILD + SHIFT / CONSTRUIR + TRANSFORMAR /
CONSTRUIRE + TRANSFORMER / BAUEN + HANDELN
BÖUN + ÖMFORMEN / COSTRUISCI +
TRASFORMARE / CONSTRUIR + MUDAR

- 1
- 2x
 - 1x
 - 1x
 - 1x
 - 1x
 - 1x
 - 1x
 - 1x
 - 1x
 - 1x

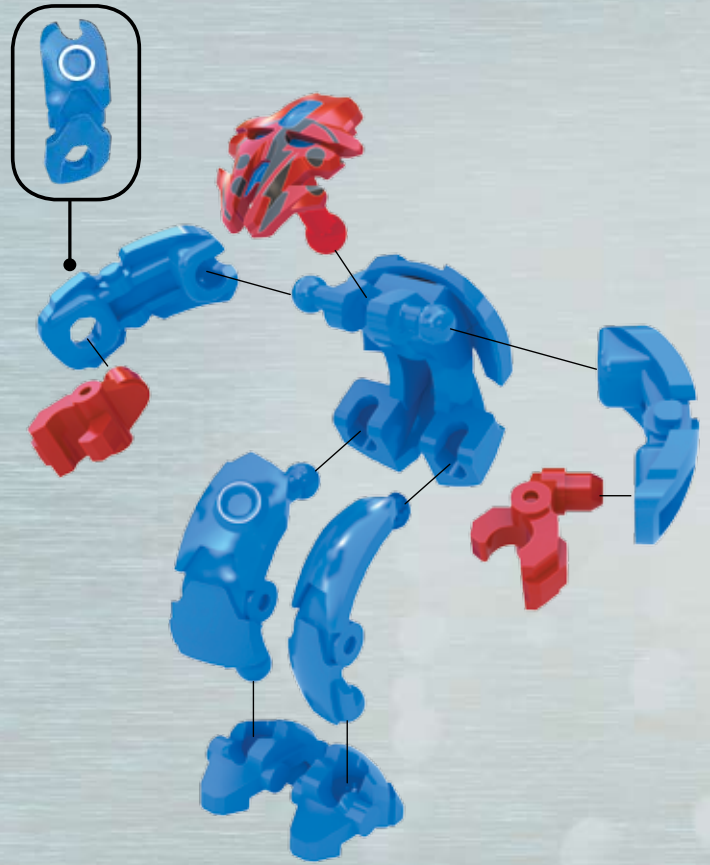

1



2

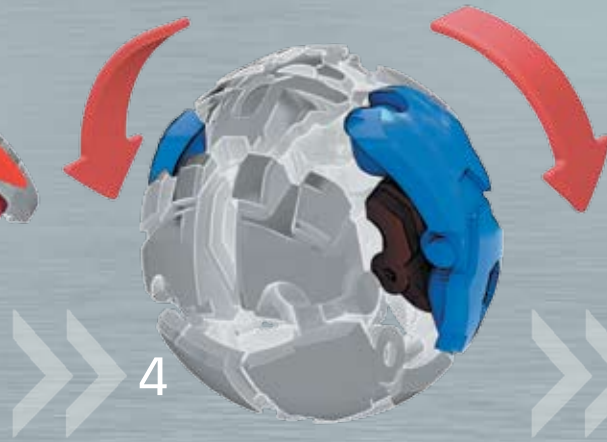
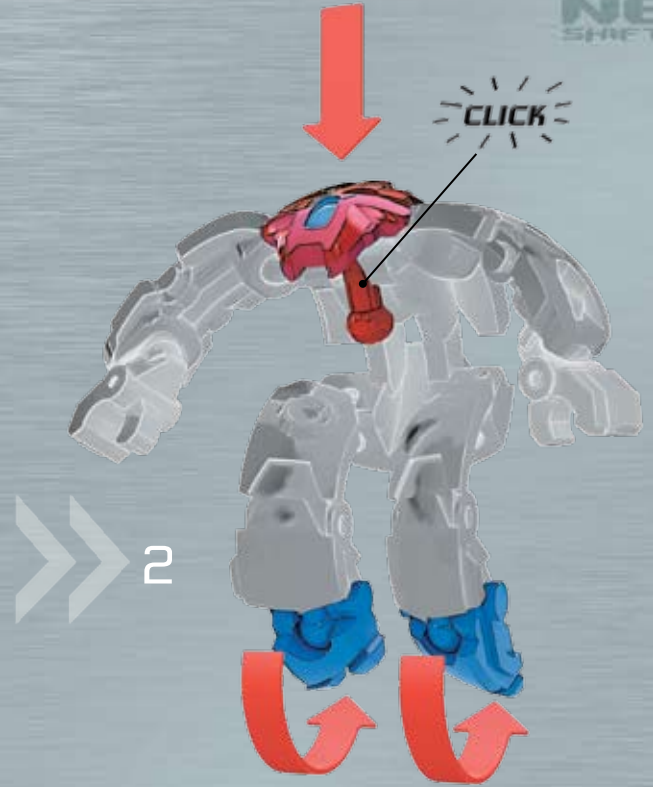

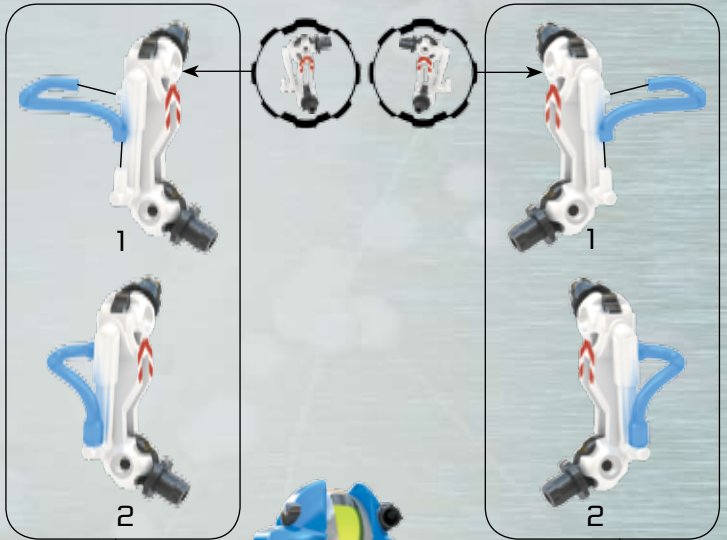
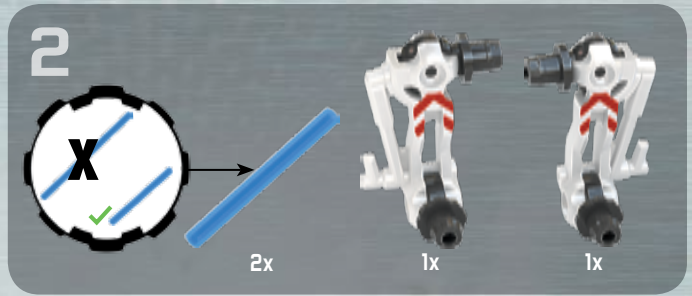
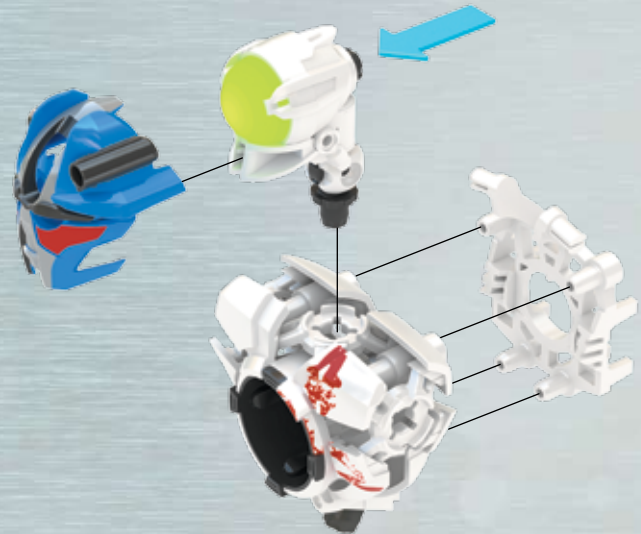
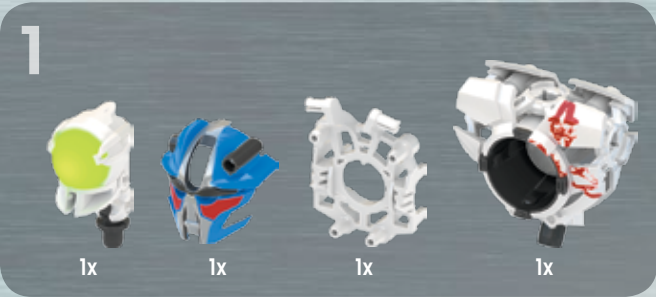

3



2x



2x



1x



1x

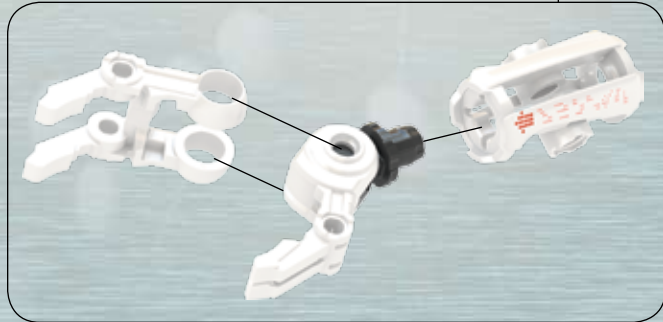
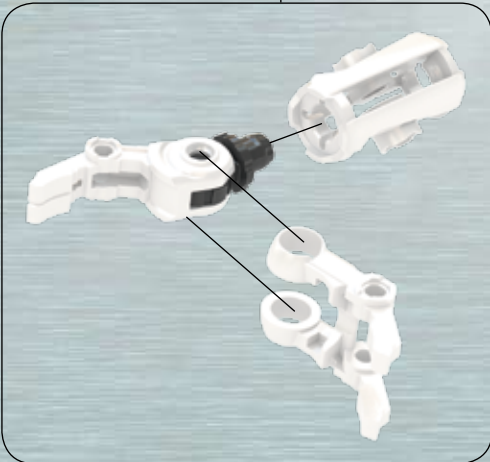

4

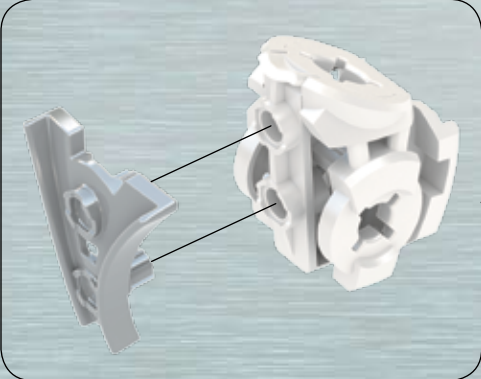

5

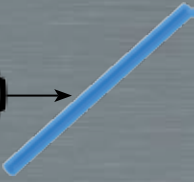

2x



1x



1x



1x



1x

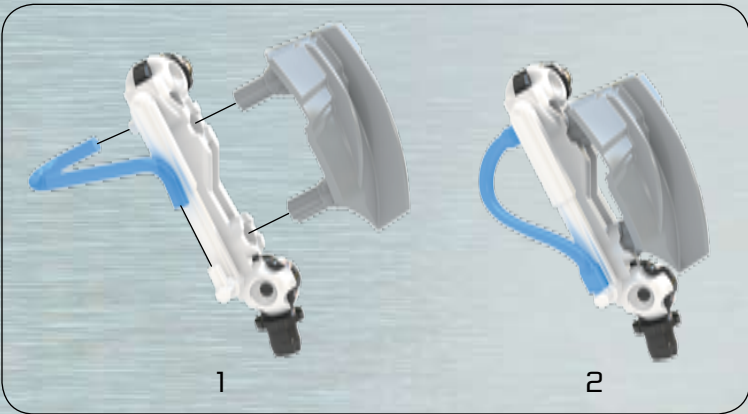

2

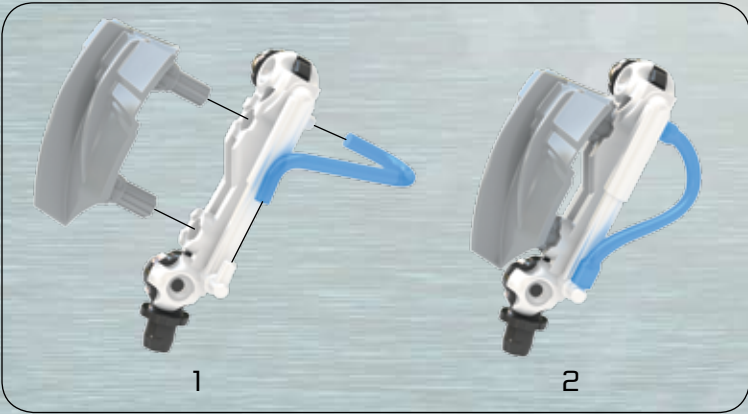

2



6

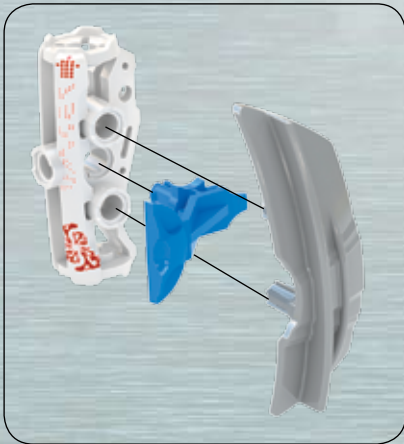
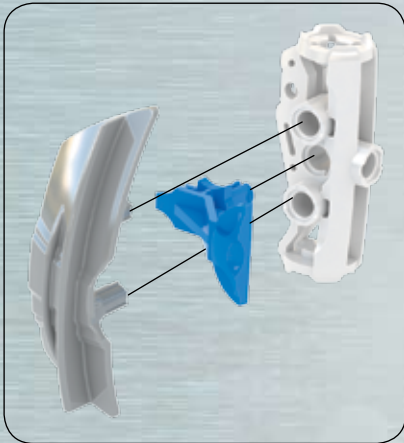

7



2x



2x



1x



1x



2x



1

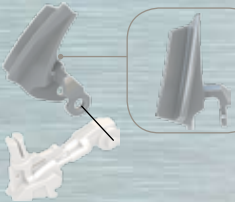

2



3

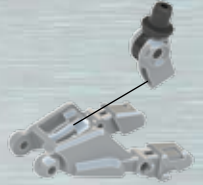

1

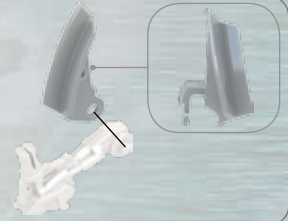

2

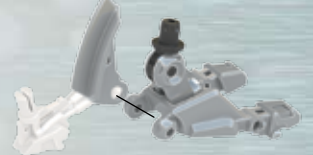

3

8



2x

2x



1x

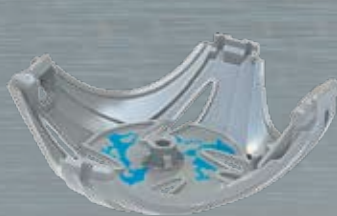

1x

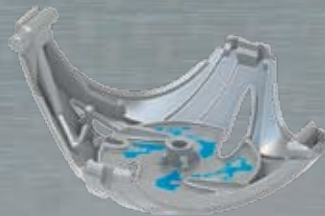

1x



stretch before using /
estíralo antes de usarlo /
étirer avant utilisation /
vor Gebrauch dehnen /
uitrekken voor gebruik /
allungare prima dell'uso /
esticar antes de usar

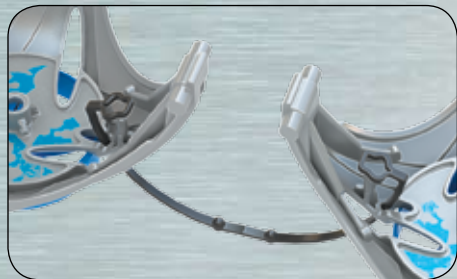
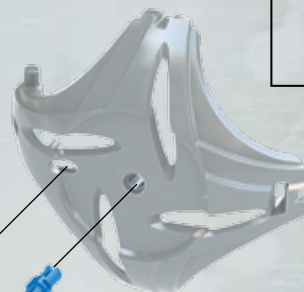
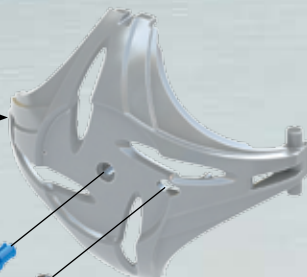

1

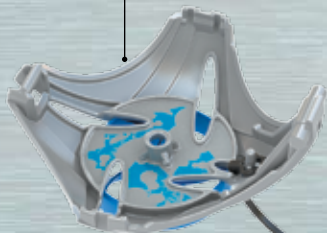

2

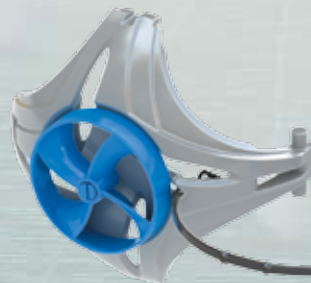
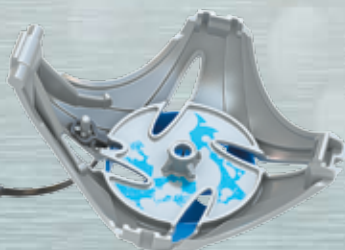

3

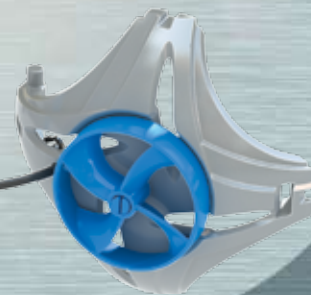

9

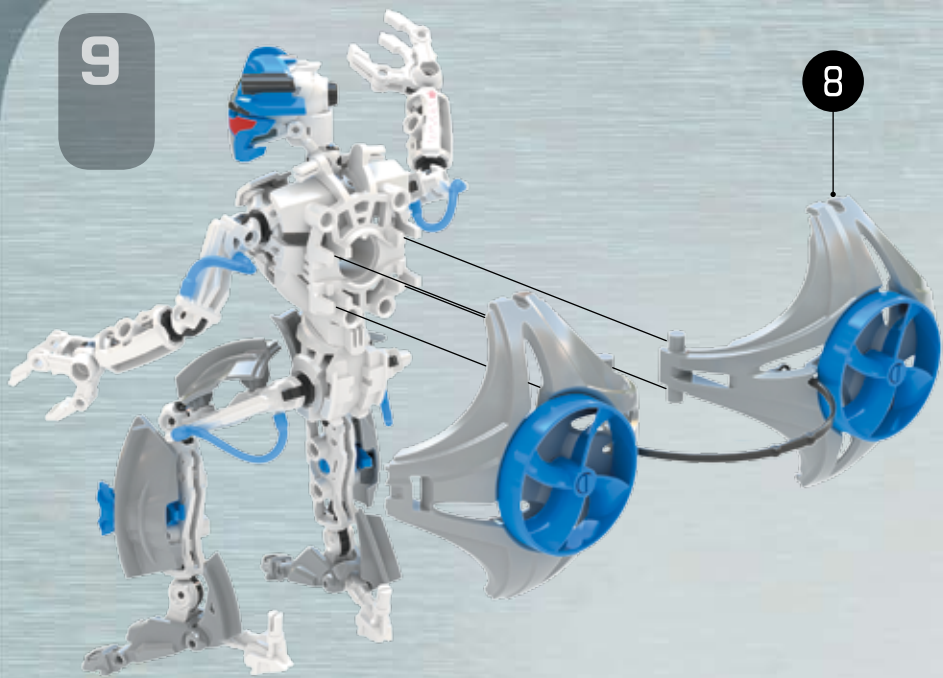

8

10



1x



11



1x



12

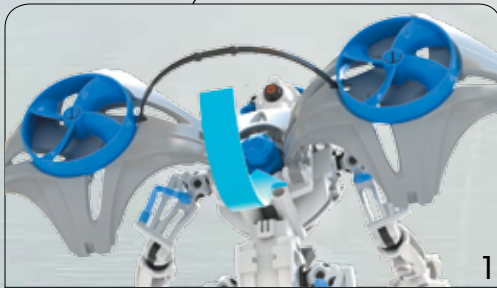

1



2



- EN Adult assistance may be required.
- ES Puede ser necesaria la ayuda de un adulto.
- FR L'assistance d'un adulte peut être requise.
- DE Hilfe eines Erwachsenen kann erforderlich sein.
- NL De hulp van een volwassene kan nodig zijn.
- IT L'assistenza di un adulto può essere necessaria.
- PT Assistência por um adulto poderá ser necessária.

13



1x



1x



1x



14



2x



1x



15

1



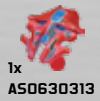

1x
AS0630313

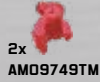

2x
AM09749TM



1x
AM09754B



1x
AM09753B



1x
AM09747B



1x
AM09748B



1x
AM09751B



1x
AM09752B



1x
AS0630314



2x
AM01793B



2x
AM09877F



2x
AS0630316



2x
AM09806B



1x
AM0869KJ



1x
AM0870KJ

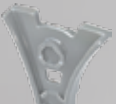

1x
AM09867KJ



1x
AS063036



1x
AM09808B

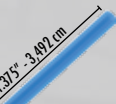

2x
AX063032B

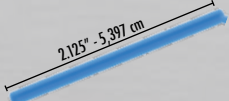

2x
AX063031B



2x
AM09734E



1x
AS0630320



1x
AM09731E



2x
AS0630318



2x
AM09738E



2x
AM09733KJ



1x
AS0630310

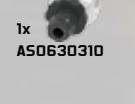

1x
AS0630311



1x
AS063037



1x
AS063038



1x
AS063039



1x
AM09864KJ



1x
AM09810E



1x
AM09864KJ



1x
AM09727E

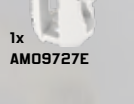

1x
AM09872KJ



1x
AM09871KJ



1x
AM09863KJ



1x
AM09864KJ



1x
AM09864KJ



1x
AM09810E



1x
AM09810E



1x
AS063033



1x
AS063032



1x
AS063035



1x
AS063031



2x
AM09859B



1x
AM09810E



1x
AM09866KJ



1x
AM09865KJ



1x
AM09866KJ



1x
AS0630321

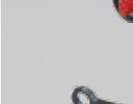

1x
AM09788F

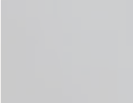

1x
AS063034

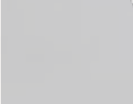

1x
AS063037



1x
AS0630319



1x
AS0630319



1x
AS0630319



1

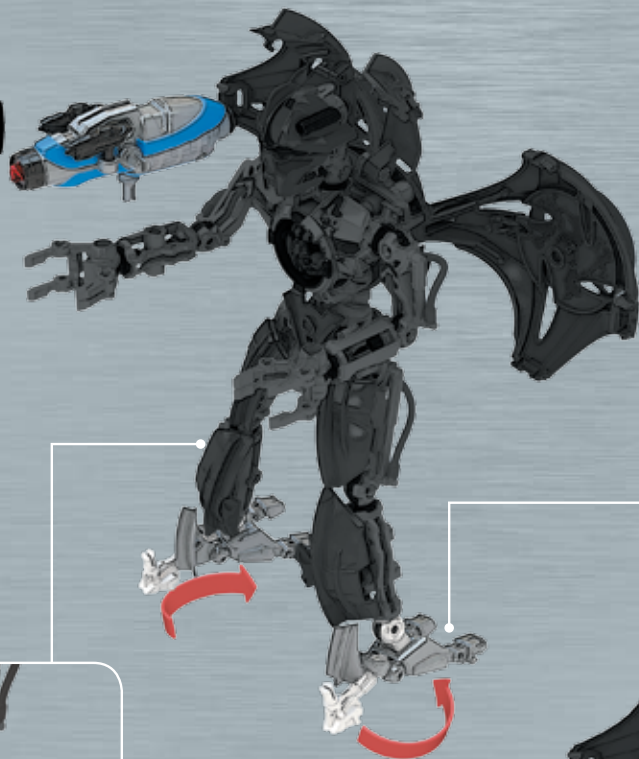

2

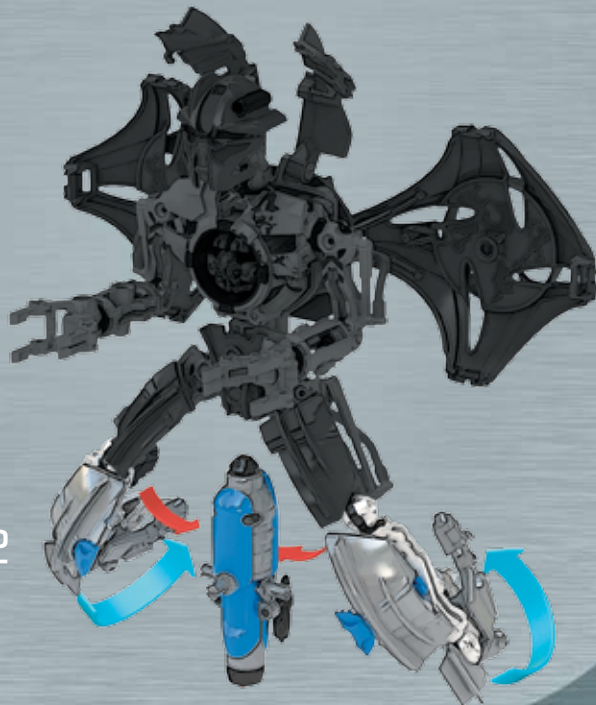



3

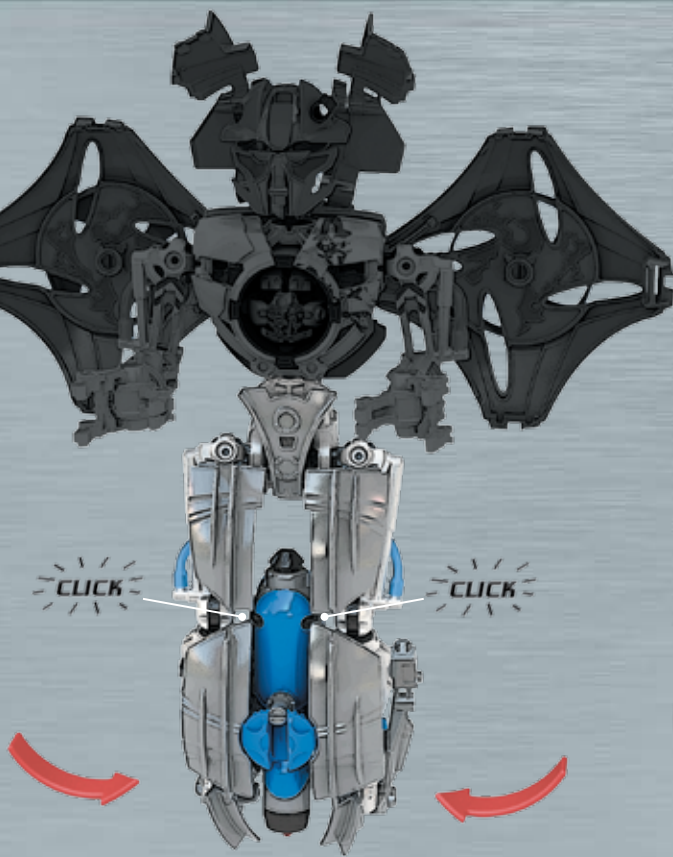

4

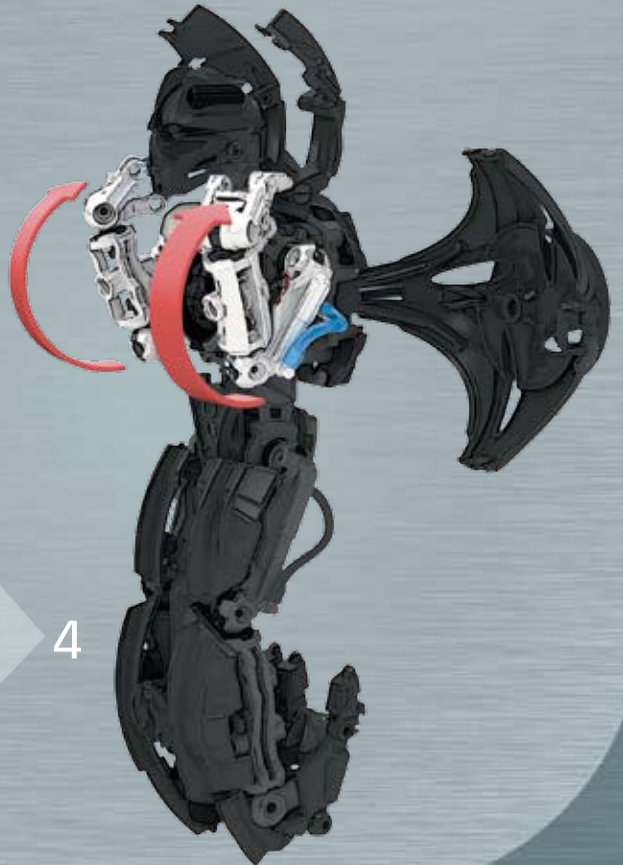

5

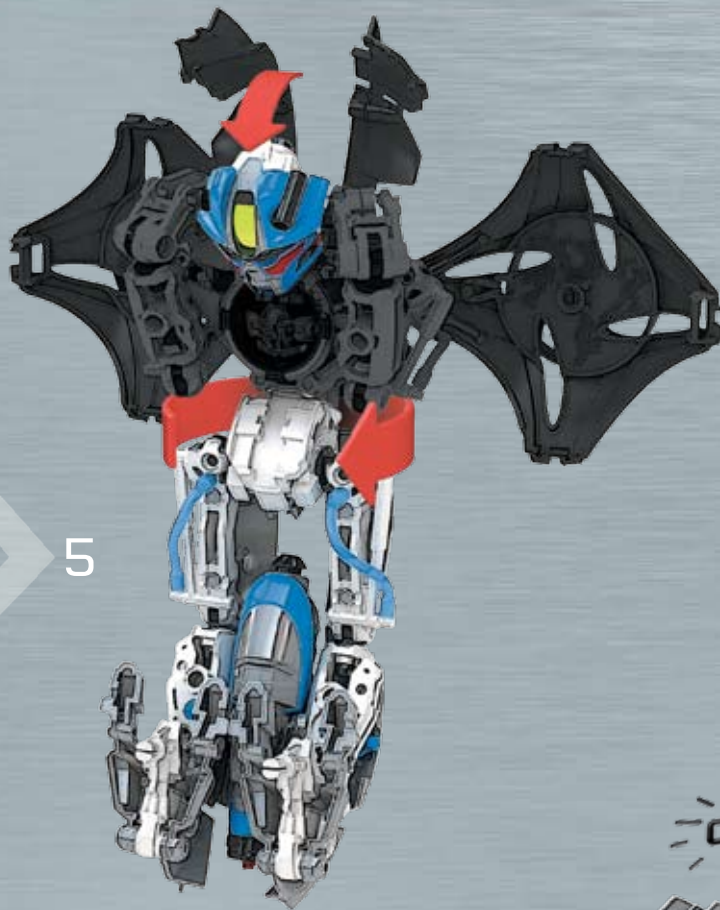

6

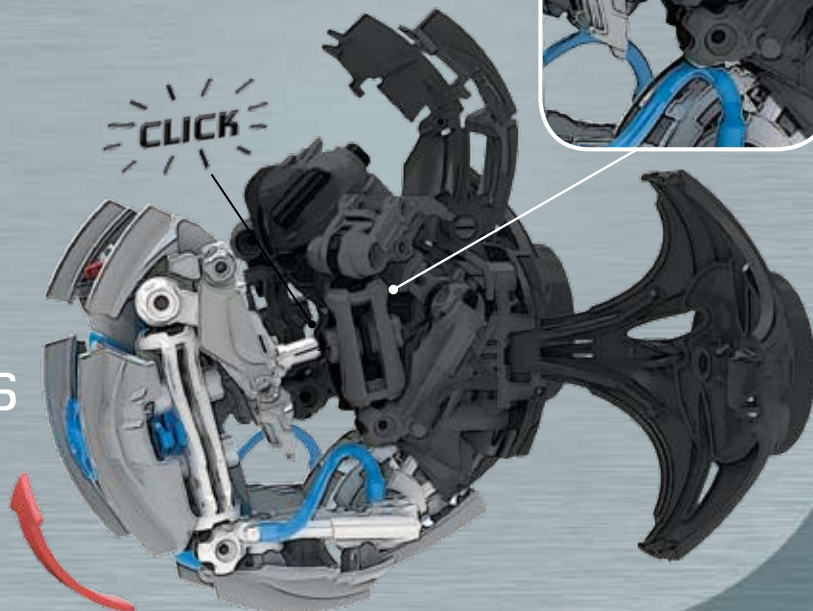

7

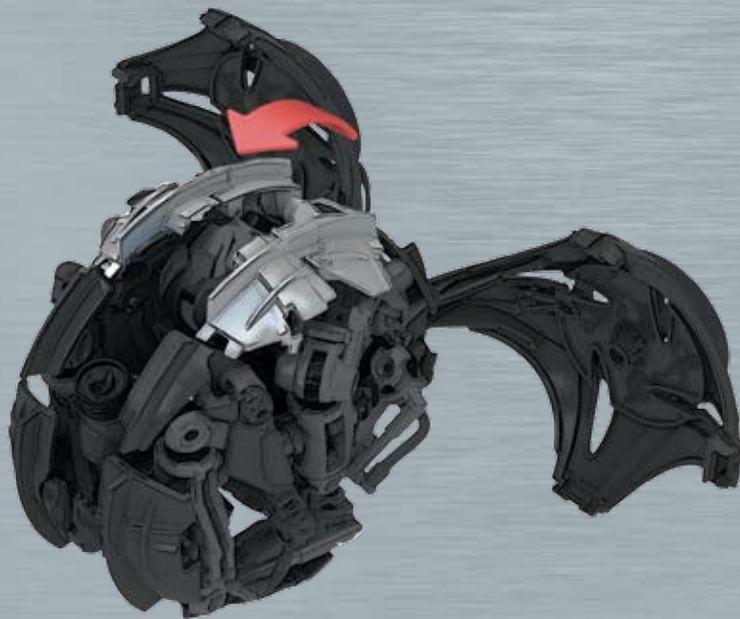

8

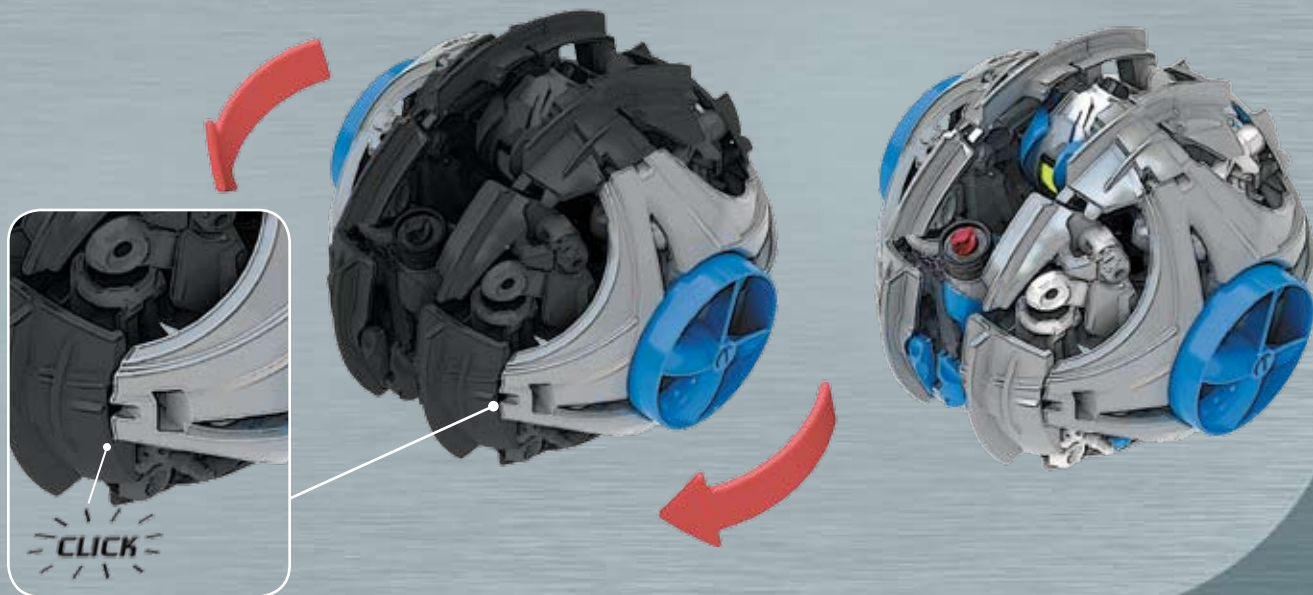

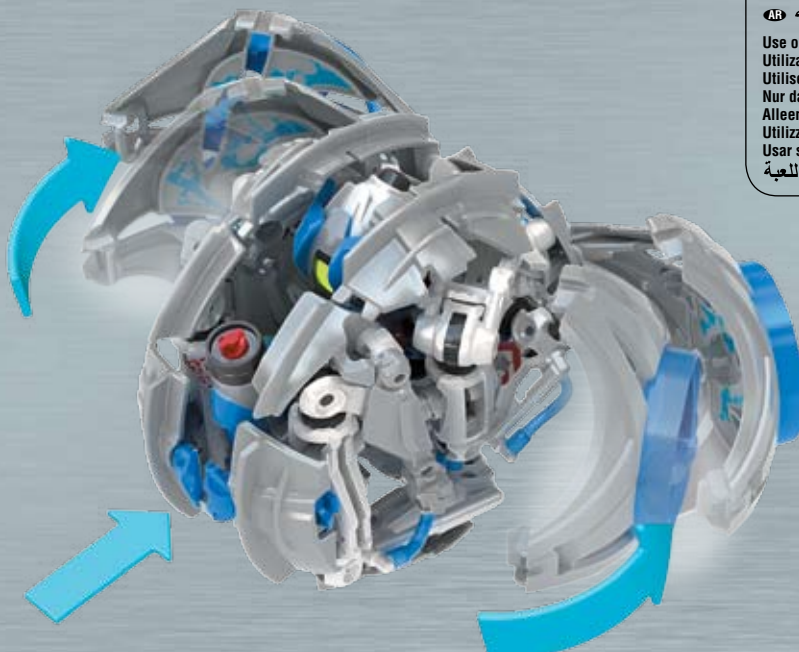

- EN** CAUTION! Do not aim at eyes or face.
- ES** ¡ADVERTENCIA! NO dirigir nunca los proyectiles hacia los ojos o la cara.
- FR** ATTENTION! Ne pas viser les yeux ou le visage.
- DE** VORSICHT! Nicht auf das Gesicht oder die Augen richten.
- NL** LET OP: Niet op ogen of gezicht richten.
- DA** ADVARSEL! Peg ikke i retning af øjne eller ansigt.
- EL** ΠΡΟΣΟΧΗ! Να μην σκοπεύετε προς τα μάτια ή το πρόσωπο.
- FI** VARO! Älä tähtää silmiin tai kasvoihin.
- IT** Attenzione! Non puntare verso gli occhi o il viso.
- NO** FORSIKTIG! Sikt ikke mot øyne eller ansikt.
- PT** ATENÇÃO! Não apontar para os olhos ou o rosto.
- SV** VAR FÖRSIKTIG! Rikta inte med ögon eller ansikte.
- JA** 注意! 目や顔に使用しないで下さい。
- ZH** 警告! 不要对准眼睛或脸。
- AR** تنبيه! لا توجه للعينين أو الوجه

Use only the projectile included with this toy.
 Utilizar solamente el proyectil incluido con el juguete.
 Utiliser seulement le projectile fourni avec le jouet.
 Nur das mit dem Spielzeug mitgelieferte Projektil verwenden.
 Alleen het met het speelgoed bijgeleverde projectiel gebruiken.
 Utilizzare soltanto il proiettile fornito con questo giocattolo.
 Usar somente o projétil incluído com este brinquedo.
 استخدم فقط القذيفة المرافقة لهذه اللعبة

BEAST



Templar warrior / Guerrero Templar / Guerrier Templar / Templar-Krieger / Templar-krjiger / Guerriero Templar / Guerreiro Templar

Light-up Laser Projection Beam! / Haz de luz láser! / Allume le faisceau de projection laser!
/ Aufleuchtender Laser-Projektionsstrahl! / Oplichtende laserstraal! / Accendi il Raggio
Laser! / Viga iluminante de Projecção Laser!



For optim results, use in dark environment. / Para
lograr resultados óptimos, utilízalo a oscuras. / Pour
obtenir un fonctionnement optimal, utiliser dans un
endroit sombre. / Funktioniert am besten in einer
dunklen Umgebung. / Een donkere omgeving geeft de
beste resultaten. / Per i migliori risultati, utilizzarlo in
oscurità. / Funciona melhor num lugar escuro.



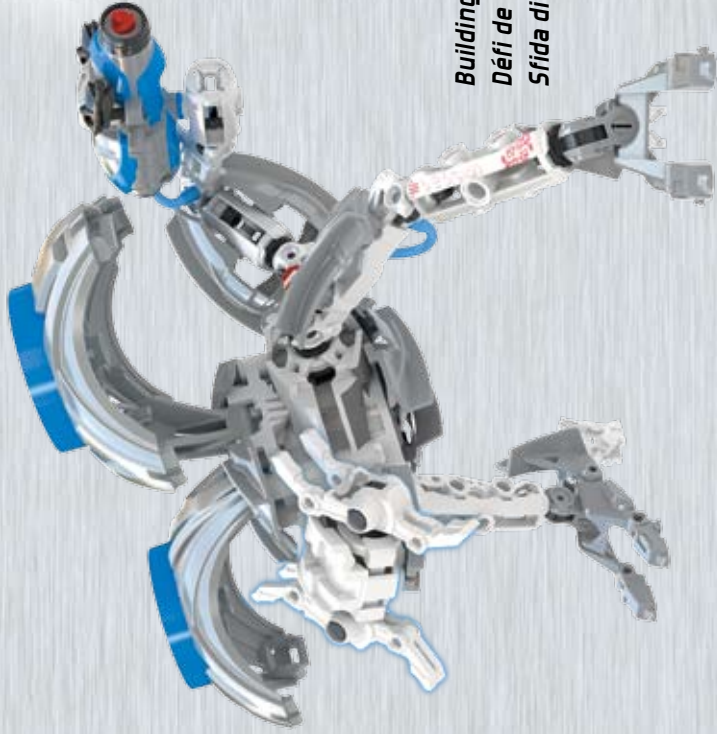
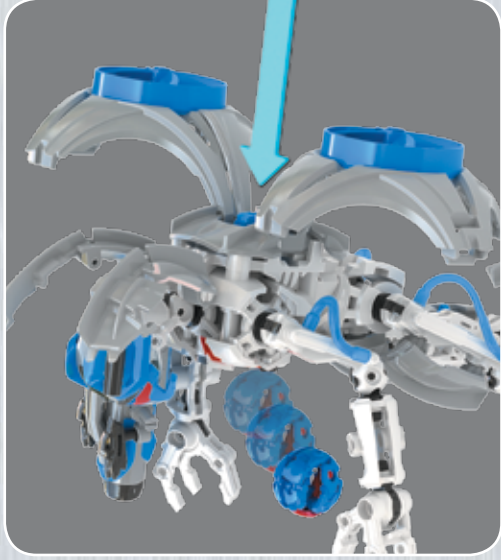

*Building challenge / Desafío de construcción /
Défi de construction / Bauaufgabe / Bouwuitdaging
Sfida di costruzione / Desafio de construção*

NEO SHIFTERS™



*Templar leader
Jefe Templar
Chef Templar
Templar-Anführer
Templar-aanvoerder
Leader Templar
Lider Templar*



6301
TERRA<->SFEAR



*Templar warrior
Guerrero Templar
Guerrier Templar
Templar-Krieger
Templar-krijger
Guerriero Templar
Guerreiro Templar*



6302
MONGRA<->TEK



*Paladin warrior
Guerrero Paladin
Guerrier Paladin
Paladin-Krieger
Paladin-krijger
Guerriero Paladin
Guerreiro Paladin*



6303
DELTA::TEK



*Paladin warrior
Guerrero Paladin
Guerrier Paladin
Paladin-Krieger
Paladin-krijger
Guerriero Paladin
Guerreiro Paladin*



6304
COZMA::TOR

Additional purchases required to collect all elements shown. / Para coleccionar todos los elementos mostrados se precisa realizar unas compras adicionales. / Des achats additionnels sont nécessaires afin d'obtenir tous les articles de la collection illustrés. / Um alle dargestellten Elemente zu sammeln sind zusätzliche Käufe erforderlich. / Verdere aankopen zijn nodig om alle afgebeelde artikelen te verzamelen. / Acquisti supplementari necessari per collezionare tutti gli elementi illustrati. / Compras adicionais são necessárias para coleccionar todos os elementos exibidos.

The Power² Change™



6308
BLAZE<->AXX



Templar warrior
Guerrero Templar
Guerrier Templar
Templar-Krieger
Templar-krijger
Guerriero Templar
Guerreiro Templar



6309
SCAR<->DORN



Templar warrior
Guerrero Templar
Guerrier Templar
Templar-Krieger
Templar-krijger
Guerriero Templar
Guerreiro Templar



Paladin warrior
Guerrero Paladin
Guerrier Paladin
Paladin-Krieger
Paladin-krijger
Guerriero Paladin
Guerreiro Paladin



6310
ATLAS::RAAN



Paladin leader
Jefe Paladin
Chef Paladin
Paladin-Anführer
Paladin-aanvoerder
Leader Paladin
Líder Paladin



6311
MAGNA::REX

ⓘ Please read these instructions carefully before first use and keep them for future reference. / ⓘ Leer estas instrucciones cuidadosamente antes de la primera utilización y guardarlas para referencia futura. / ⓘ Il est recommandé de lire attentivement ce feuillet avant la première utilisation et de le conserver pour référence future. / ⓘ Die Gebrauchsanleitung bitte durchlesen und aufbewahren. / ⓘ Wij raden u aan deze handleiding zorgvuldig te lezen en te bewaren voor eventuele raadpleging op een later tijdstip. / ⓘ Leggere le istruzioni prima di cominciare ad usare il gioco e conservarle per referenze future. / ⓘ Leia as instruções antes do primeiro uso e guarde-as para futura referência.

ⓘ **WARNING :**
CHOKING HAZARD. - Small parts.
Toy contains a small ball.
Not for children under 3 years.

ⓘ **ADVERTENCIA :**
PELIGRO DE ASFIXIA. - Contiene piezas pequeñas.
El juguete contiene una bola pequeña.
No recomendado para niños menores de 3 años.

ⓘ **AVERTISSEMENT :**
RISQUE DE SUFFOCATION. - Présence de petits éléments.
Le jouet contient une petite balle.
Ne convient pas aux enfants de moins de 3 ans.

ⓘ **WARNING:**
ERSTICKUNGSGEFAHR. - Enthält kleine Teile.
Ein kleiner Ball ist im Spielzeug begriffen.
Nicht für Kinder unter 3 Jahren geeignet.

ⓘ **CAUTION:**

- Do not leave this toy close to a source of heat or in direct sunlight.
- Do not operate this toy outdoors.
- Operate this toy in a dry area.
- Avoid sand and water. If moisture gets inside the electronic compartment, remove the batteries and allow it to dry thoroughly before using.

ⓘ **ADVERTENCIA:**

- No exponer este juguete a una fuente de calor ni a los rayos directos del sol.
- No utilizar este juguete en el exterior.
- Utilizar este juguete en un lugar seco.
- Evitar el contacto con agua o arena. Si la humedad penetra en el compartimento eléctrico, retirar las pilas y dejar secar completamente antes de volver a utilizar el juguete.

ⓘ **AVERTISSEMENT:**

- Ne pas laisser ce jouet près d'une source de chaleur ou directement au soleil.
- Ne pas utiliser ce jouet dehors.
- Utiliser ce jouet dans un endroit sec.
- Ne pas utiliser dans l'eau ni dans le sable. Si l'humidité pénètre dans le compartiment électronique, enlever les piles et laisser sécher complètement avant d'utiliser à nouveau.

ⓘ **ACHTUNG:**

- Dieses Spielzeug darf keiner Wärmequelle und keiner direkten Sonneneinstrahlung ausgesetzt werden.
- Mit diesem Spielzeug sollte nicht im Freien gespielt werden.
- Mit diesem Spielzeug sollte nur in einem trockenen Bereich gespielt werden.
- Mit dem Spielzeug sollte nicht im Wasser oder im Sand gespielt werden. Sollte das Batteriefach feucht werden, die Batterien herausnehmen und das Batteriefach vor Weiterbenutzung völlig trocken lassen.

ⓘ **WAARSCHUWING:**

- Stel het speelgoed niet bloot aan een hittebron of aan direct zonlicht.
- Gebruik het speelgoed niet buitenshuis.
- Gebruik het speelgoed op een droge plek.
- Vermijd zand en water. Mocht er toch vocht in het elektronicavak terechtkomen, verwijder de batterijen dan en laat het speelgoed grondig drogen voordat het weer wordt gebruikt.

ⓘ **ATTENZIONE:**

- Non lasciare questo giocattolo in prossimità di una fonte di calore o esposto alla luce del sole.
- Non adoperare questo giocattolo all'esterno.
- Adoperare questo giocattolo solo in luoghi asciutti.
- Evitare sabbia ed acqua. Se l'umidità dovesse penetrare nel compartimento elettronico, togliere le pile e lasciarlo asciugare completamente prima di adoperare.

ⓘ **ATENÇÃO:**

- Não deixe este brinquedo próximo de uma fonte de calor ou directamente exposto à luz solar.
- Não opere este brinquedo ao ar livre.
- Opere este brinquedo numa área seca.
- Evite a areia e a água. Se entrar humidade no compartimento electrónico, remova as baterias e deixe secar completamente antes de usar novamente.

ⓘ **WAARSCHUWING:**
VERSTIKKINGSGEVAAR. - Bevat kleine onderdelen.
Speelgoed bevat een klein balletje.
Niet geschikt voor kinderen onder de 3 jaar.

ⓘ **ADVARSEL:**
KVÆLNINGSFARE. - Indeholder smådele.
Legetøjet indeholder en lille bold.
Ikke til børn under 3 år.

ⓘ **ΠΡΟΕΙΔΟΠΟΙΗΣΗ:**
ΚΙΝΔΥΝΟΣ ΠΝΙΣΙΜΑΤΟΣ. - Περιέχει μικρά αντικείμενα.
Το παιχνίδι περιέχει ένα μολύβι.
Όχι για παιδιά κάτω των 3 ετών.

ⓘ **VAROITUS:**
TUKEHTUMISVAARA. - Sisältää pieniä osia.
Leluun sisältyy pieni pallo.
Ei alle 3-vuotiaille lapsille.

ⓘ **ATTENZIONE:**
PERICOLO DI SOFFOCAMENTO. - Contiene piccole parti.
Il giocattolo comprende una pallina.
Non indicato per bambini sotto i 3 anni.

ⓘ **ADVARSEL:**
KVELNINGSFARE. - Inneholder små deler.
Leketøy inneholder en liten ball.
Kun for barn over 3 år.

ⓘ **ATENÇÃO:**
PERIGO DE ASFIXIA. - Contém peças pequenas.
O brinquedo contém uma pequena bola.
Não é concebido para crianças de menos de 3 anos.

ⓘ **VARNING:**
KVÄVNINGSRISK. - Innehåller små delar.
Leksaken innehåller en liten boll.
Inte för barn under 3 år.

ⓘ **警告:**
窒息の危険性 小さな部品が含まれています
小さな玉が含まれています。
3歳以下の子供には与えないで下さい。

ⓘ **警告:**
有窒息危險 包含有小部件
此玩具含有一個小球。
不适合3岁以下的小孩玩。

ⓘ **تحذير:**
خطر اختناق - قطع صغيرة.
تحتوي اللعبة على كرة صغيرة.
غير صالحة للأطفال أقل من 3 سنوات.

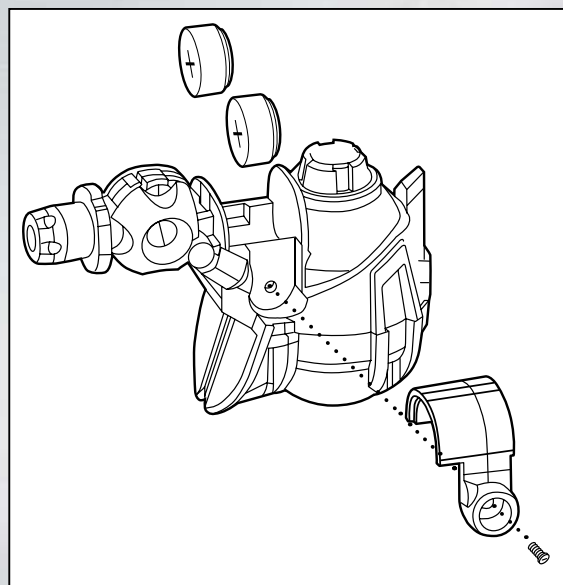

Non-rechargeable batteries included.
Incluye pilas no recargables.
Piles fournies non-rechargeables.
Nichtwiederaufladbare Batterien begriffen.
Niet-oplaadbare batterijen meegeleverd.
Batterie non ricaricabili fornite.
Pilhas não-recarregáveis incluídas.



2 X 1.5V

This toy uses 2 alkaline button cell batteries (AG3, LR41, 192 or equivalent).
Este juguete utiliza 2 pilas alcalinas de célula de botón (AG3, LR41, 192 o equivalente).
Ce jouet nécessite 2 piles boutons alcalines (AG3, LR41, 192 ou l'équivalent).
Dieses Spielzeug wird mit 2 Alkali-Knopfbatterien betrieben (AG3, LR41, 192 oder Entsprechung).
Dit speelgoed gebruikt 2 alkaline knoopcelbatterijen (AG3, LR41, 192 of gelijkwaardig).
Questo giocattolo usa 2 microbatterie alcaline (AG3, LR41, 192 o equivalenti).
Este brinquedo emprega 2 pilhas finas alcalinas (AG3, LR41, 192 ou equivalente).

EN Problem Lights do not turn on.	Possible causes Dead batteries. Incorrect battery placement. Dirty battery contacts.	Try these solutions Replace batteries. Remove batteries and install according to instructions and diagram. Clean battery terminals.
ES Problema Luces no se encienden.	Causas posibles Las pilas están gastadas. Las pilas han sido colocadas incorrectamente. Los bornes están sucios.	Intente lo siguiente Cambie las pilas. Retire las pilas y vuelva a colocarlas, siguiendo las instrucciones y diagramas. Limpie los bornes.
FR Problème Les lumières ne s'allument pas.	Causes possibles Piles usées. Piles mal installées. Contacts encrassés.	Essayez ces solutions Remplacer les piles. Enlever les piles et les remettre en place selon les instructions et diagrammes. Nettoyer les contacts des piles.
DE Problem Lichter schalten nicht ein.	Mögliche Ursache Batterien sind leer. Batterien wurden falsch eingesetzt. Batteriekontakte sind schmutzig.	Mögliche Lösung Batterien austauschen. Batterien herausnehmen und laut Anweisung und Diagramm neu einlegen. Batterieklemmen reinigen.
NL Probleem Lichten gaan niet aan.	Mogelijke oorzaken Legge batterijen. Batterijen zijn verkeerd ingelegd. Vuile batterijcontacten.	Probeer de volgende oplossingen Vervang de batterijen. Verwijder de batterijen en leg ze opnieuw in zoals aangegeven in de handleiding en op de afbeelding. Reinig de polen.
IT Problemi Le luci non si accendono.	Cause possibili Batterie scaricate. Batteria piazzata incorrettamente. Contatti della batteria sporchi.	Prova queste soluzioni. Rimpiazzare le batterie. Rimuovere le batterie ed installarle secondo le istruzioni e il diagramma. Pulire i contatti della batteria.
PT Problemas As luzes não acendem.	Possíveis causas Pilhas esgotadas. Colocação incorreta de pilhas. Contactos de pilha sujos.	Tentar estas soluções. Mudar as pilhas. Retirar as pilhas e instalar de acordo com instruções e diagrama. Limpar os terminais de pilhas.

EN CAUTION: Batteries are to be changed by an adult. Do not leave batteries within reach of children.
ES ADVERTENCIA: Las pilas debe cambiarlas un adulto. No dejar las pilas al alcance de los niños.
FR ATTENTION : Le changement de piles doit être réalisé par un adulte. Ne pas laisser les piles à la portée des enfants.
DE ACHTUNG: Die Batterien müssen von einem Erwachsenen ausgewechselt werden. Batterien für Kinder unzugänglich aufbewahren.
NL OPGEPAST: De batterijen moeten door een volwassene worden vervangen.
DA ADVARSEL: Batterierne skal udskiftes af en voksen. Efterlad ikke batterierne indenfor børns rækkevidde.
EL ΠΡΟΣΟΧΗ: Οι μπαταρίες πρέπει να αλλάξθούν από ενήλικο. Μην αφήνετε τις μπαταρίες κοντά στα παιδιά.
FI HUOMIO: Aikuisen tulee vaihtaa paristot. Älä jätä paristoja lasten ulottuville.
IT ATTENZIONE: Le pile devono essere cambiate da un adulto. Non lasciare le pile alla portata dei bambini.
NO ADVARSEL: Batteriene må skiftes av en voksen. Ikke ha batteriene liggende innen barns rekkevidde.
PT ATENÇÃO: As pilhas devem ser trocadas por um adulto. Não deixe que as pilhas estejam ao alcance de menores.
SV VARNING: Batterierna bör bytas av en vuxen. Lämna inte batterierna inom räckhåll för barn.
JA 注意：電池の交換は大人がしてください。電池は、こどもの手の届かないところに保管してください。
ZH 注意：電池須由成人更換。請勿讓小孩接觸電池。
AR تنبيه: يجب أن يغير البطارية شخص بالغ. لا تترك البطارية في متناول الأطفال.

EN Batteries included with this toy are for demonstration purposes only. In order to get the best performance from this toy, we recommend that fresh alkaline batteries be inserted prior to use. / **ES** Las pilas incluidas con este juguete únicamente permiten activar el modo de demostración. A fin de lograr un funcionamiento óptimo del juguete, se aconseja introducir pilas alcalinas nuevas antes de utilizarlo. / **FR** Les piles fournies avec ce jouet ne servent que pour activer le mode de démonstration. Afin de maximiser le rendement de ce jouet, nous recommandons d'installer des piles alcalines neuves avant de l'utiliser. / **DE** Die in diesem Spielzeug mitgelieferten Batterien sind nur für die "PROBIER MICH AUS"-Demonstration gedacht. Um die beste Leistung dieses Spielzeugs zu erzielen, empfiehlt es sich, vor Inbetriebnahme neue Alkalibatterien einzulegen. / **NL** De bij dit speelgoed ingesloten batterijen zijn slechts bedoeld voor demonstratiedoeleinden. Voor optimaal functioneren van dit speelgoed raden wij u aan vóór gebruik nieuwe alkalische batterijen in te leggen. / **IT** Le batterie fornite con questo giocattolo sono solo a scopo dimostrativo. Per avere i migliori risultati da questo giocattolo, vi raccomandiamo di inserire delle batterie alcaline prima di utilizzare il giocattolo. / **PT** Pilhas incluídas com este brinquedo são unicamente para fins de demonstração. Para obter o melhor funcionamento deste brinquedo, aconselhamos inserir pilhas alcalinas novas antes do uso.

EN BATTERY INSTALLATION

- Use a phillips (star-bit) screwdriver to unscrew the door of the battery compartment.
- Lift and remove the compartment door.
- Insert the batteries according to the correct polarity shown.
- Replace the door and the screw, do not over-tighten the screw.

ES INSTALACIÓN DE LAS PILAS

- Utilizar un destornillador en cruz (o con punta de estrella) para abrir la tapa del compartimiento de las pilas.
- Levantar y retirar la tapa del compartimiento de las pilas.
- Colocar las pilas respetando la polaridad indicada.
- Reponer la puerta y el tornillo, evitando apretarlo demasiado.

FR MISE EN PLACE DES PILES

- Avec un tournevis cruciforme, dévisser la porte du compartiment à piles.
- Soulever et ouvrir la porte du compartiment.
- Mettre en place les piles suivant la polarité indiquée.
- Remettre en place la porte et la vis, sans trop serrer cette dernière.

DE BATTERIEN EINSETZEN

- Einen Kreuzschlitz-Schraubendreher benutzen, um die Abdeckung des Batteriefachs loszuschrauben.
- Die Abdeckung des Batteriefachs anheben und abnehmen.
- Die Batterien einsetzen. Dabei auf die richtige Polarität achten.
- Tür und Schraube wieder einsetzen, ohne diese Schraube übermäßig anzuziehen.

NL INLEGGEN VAN DE BATTERIEN

- Gebruik een kruiskopschroevendraaier om het klepje van het batterijvak los te schroeven.
- Licht het klepje op en verwijder het.
- Leg de batterijen in met inachtneming van de juiste polariteit, zoals aangegeven.
- Plaats het paneel en de schroef terug en draai niet te vast aan.

IT INSTALLAZIONE DELLA BATTERIA

- Utilizzare un cacciavite a croce per rimuovere lo sportello d'accesso alla batteria.
- Sollevare e rimuovere lo sportello.
- Inserire le batterie secondo le corrette polarità illustrate.
- Rimettere a posto lo sportello e vite, non stringere troppo la vite.

PT INSTALAÇÃO DE PILHAS

- Usar uma chave de parafusos Philips (ponta em forma de estrela) para desaparafusar a tampa do compartimento de pilhas.
- Levantar e retirar a tampa do compartimento.
- Inserir as pilhas de acordo com as polaridades correctas mostradas.
- Repor a tampa e o parafuso sem apertar este demasiadamente.

EN For Europe: Please return the electric module to the store for recycling.

ES En Europa: Por favor, devuelva el módulo eléctrico a la tienda para que lo reciclen.

FR Europe: Veuillez rapporter le module électronique au magasin pour recyclage.

DE In Europa: Das elektrische Modul bitte zur Wiederverwertung ins Geschäft zurückbringen.

NL In Europa: A.u.b. de elektrische module naar de winkel terugsturen voor hergebruik.

DA I Europa: Værsgo at sende den elektroniske modul tilbage til butikken for genanvendelse.

EL Στην Ευρώπη: Παρακαλώ να επιστρέψετε στο κατάστημα το ηλεκτρικό εξάρτημα για ανακύκλωση.

FI Euroopassa: Palauta sähkökomponentti liikkeeseen kierrätettäväksi.

IT Europa: Vogliate riportare il modulo elettronico al negozio per riciclaggio.

NO I Europa: Vennligst send den elektriske modulen tilbake til butikken for gjenvinning.

PT Na Europa: É favor devolver o módulo eléctrico à loja para reciclagem.

SV I Europa: Var god lämna tillbaka elmodulen till affären för återanvändning.

ZH 欧州向：電子モジュールはリサイクルのため販売店に返却ください。

AR 若居住歐洲：請將電動元件返還商店以便回收利用

AR بالنسبة لأوروبا: يرجى إعادة الوحدة الكهربائية للمحل لغرض إعادة التصنيع.



(EN) CAUTION: TO AVOID BATTERY LEAKAGE:

1. See the diagram to know how to remove and insert batteries.
2. Non-rechargeable batteries must never be recharged.
3. Rechargeable batteries must be removed from toy before being recharged and rechargeable batteries should be charged under adult supervision.
4. Do not mix alkaline, standard (carbon zinc), or rechargeable (nickel cadmium) batteries. Do not mix used and new batteries together.
5. Only batteries of the recommended type or of a similar type should be used.
6. Batteries must be inserted according to the correct polarity (see diagram).
7. Remove batteries from toy when storing for an extended period of time or if batteries are exhausted.
8. The supply terminals must not be short-circuited.

(ES) ADVERTENCIA: PARA EVITAR QUE LAS PILAS SE SULFATEN:

1. Consultar el diagrama para saber cómo retirar e introducir las pilas.
2. No recargar jamás pilas que no sean recargables.
3. Retirar las pilas recargables del juguete antes de recargarlo; las pilas recargables deben cargarse bajo la supervisión de un adulto.
4. No mezclar pilas alcalinas, con pilas standard (carbon zinc) ni tampoco con pilas recargables (níquel cadmio). No mezclar pilas usadas con pilas nuevas.
5. Solamente deben utilizarse las pilas del tipo recomendado o de tipo similar.
6. Colocar las pilas respetando la polaridad correcta (ver diagrama).
7. Retirar las pilas del juguete cuando vaya a guardarlo durante un periodo largo de tiempo o si las pilas están gastadas.
8. No originar cortocircuitos en los bornes del compartimiento de las pilas.

(FR) AVERTISSEMENT: POUR ÉVITER LA FUITE DES PILES:

1. Consulter le diagramme pour savoir comment enlever ou mettre en place les piles.
2. Ne jamais recharger des piles non-rechargeables.
3. Les accumulateurs doivent être enlevés du jouet avant d'être chargés et les accumulateurs ne doivent être chargés que sous la surveillance d'un adulte.
4. Différents types de piles alcalines, standard (carbone zinc) ou d'accumulateurs (nickel cadmium) ne doivent pas être mélangés. Des piles neuves et usagées ou des accumulateurs neufs et usagés ne doivent pas être mélangés.
5. Seuls des piles ou des accumulateurs du type recommandé ou d'un type similaire doivent être utilisés.
6. Les piles et les accumulateurs doivent être mis en place en respectant la polarité (voir le diagramme).
7. Retirer les piles avant rangement du jouet pour une longue période ou bien si les piles sont usées.
8. Les bornes d'une pile ou d'un accumulateur ne doivent pas être mises en court-circuit.

(DE) WARNUNG: UM DAS AUSLAUFEN DER BATTERIEN ZU VERMEIDEN:

1. Einlegen und Auswechseln der Batterien.
2. Nichtwiederaufladbare Batterien dürfen nicht wieder aufgeladen werden.
3. Wiederaufladbare Batterien müssen zum Aufladen aus dem Spielzeug herausgenommen werden und dürfen nur unter Aufsicht von Erwachsenen aufgeladen werden.
4. Alte und neue Batterien nicht zusammen verwenden. Alkalibatterien, Standardbatterien (Kohle-Zink-Batterien), wiederaufladbare Batterien (Nickel-Cadmium) nicht mischen. Nur Batterien derselben Sorte verwenden.
5. Nur Batterien der empfohlenen oder ähnlichen Sorte verwenden.
6. Batterien gemäß Polarität einlegen (siehe Abbildung).
7. Batterien bei längerer Lagerung, oder wenn sie verbraucht sind, aus dem Spielzeug herausnehmen
8. Die Batterieanschlüsse nicht kurzschliessen.

(NL) WAARSCHUWING: VOORKOMEN VAN LEKKENDE BATTERIJEN:

1. Wijze waarop vervangbare batterijen moeten worden verwijderd en ingelegd.
2. Niet-oplaadbare batterijen mogen niet worden opgeladen.
3. Oplaadbare batterijen dienen vóór het opladen uit het speelgoed te worden verwijderd en alleen onder toezicht van een volwassene te worden opgeladen.
4. Gebruik alkalische, standaard- (zinkkoolstof) of oplaadbare (nikkelcadmium) batterijen niet tesamen. Gebruik oude en nieuwe batterijen niet tesamen.
5. Uitsluitend batterijen van het aanbevolen type of van een vergelijkbaar type mogen worden gebruikt.
6. Batterijen moeten worden ingelegd met inachtneming van de juiste polariteit (zie afbeelding).
7. Haal de batterijen uit het speelgoed wanneer het voor een lange periode niet wordt gebruikt of als de batterijen leeg zijn.
8. De voedingsklem mag niet worden kortgesloten.

(DA) ADVARSEL: SÅDAN UNDGÅS BATTERI-LÆKAGE:

1. Se diagrammet om hvordan batterier udtages og indsættes.
2. Ikke opladelige batterier må aldrig oplades.
3. Opladelige batterier skal tages ud af legetøjet før det oplades, og opladelige batterier skal oplades i tilstedeværelse af en voksen.
4. Opladelige (nikkel-kadmium) batterier og alkalisk-, standardbatterier (zink-kul) må ikke blandes. Nye og brugte batterier må ikke bruges sammen.
5. Brug kun den foreslåede type batterier eller lignende type.
6. Sæt batterier i med polerne vendt den rigtige vej (se diagram).
7. Tag batterierne ud, hvis legetøjet ikke skal bruges i længere tid eller hvis batterierne er udbændte.
8. Batteriterminalerne må ikke kortsluttes.

(EL) ΠΡΟΣΟΧΗ : ΓΙΑ ΤΗΝ ΑΠΟΦΥΓΗ ΔΙΑΡΡΟΗΣ ΤΗΣ ΜΠΑΤΑΡΙΑΣ :

1. Δείτε το διάγραμμα για να δείτε πως να αφαιρείτε και να τοποθετείτε τις μπαταρίες.
2. Δεν πρέπει ποτέ να επαναφορτίζετε τις μη επαναφορτιζόμενες μπαταρίες.
3. Θα πρέπει να αφαιρείτε τις επαναφορτιζόμενες μπαταρίες από το παιχνίδι πριν τις επαναφορτίσετε και θα πρέπει να φορτίζετε τις επαναφορτιζόμενες μπαταρίες κάτω από την επίβλεψη ενήλικου.
4. Να μην αναμιγνύετε αλκαλικές, κανονικές (άνθρακα - ψευδάργυρου), ή επαναφορτιζόμενες (νικελίου καδμίου) μπαταρίες. Να μην τοποθετείτε καινούργιες και μεταχειρισμένες μπαταρίες μαζί.
5. Να χρησιμοποιείτε μόνο μπαταρίες του συνιστώμενου τύπου ή ισοδύναμες.
6. Θα πρέπει να εισάγετε τις μπαταρίες σύμφωνα με τη σωστή πολικότητα.
7. Να αφαιρείτε τις μπαταρίες από το παιχνίδι όταν το αποθηκεύετε για παρατεταμένο χρονικό διάστημα ή εάν έχουν εξαντληθεί οι μπαταρίες.
8. Δεν θα πρέπει να βραχυκυκλώνετε τα τερματικά παροχής.

VARO: PARISTOJEN VUOTAMISEN ESTÄMINEN:

1. Katso kuvasta, kuinka poistat ja asennat paristot.
2. Ei-ladattavia paristoja ei koskaan saa ladata.
3. Ladattavat paristot on poistettava leikkikalusta ennen niiden lataamista ja lataaminen on tehtävä aikuisen valvonnassa.
4. Älä sekoita alkali-, normaali- (hiili-sinkki) tai ladattavia (nikkelikadmium) -paristoja. Älä sekoita käytettyjä ja uusia paristoja keskenään.
5. Käytä vain suositeltuja tai samankaltaisia paristoja.
6. Paristot on asennettava navat oikein päin (katso kuvaa).
7. Poista paristot leikkikalusta, kun leikkikalua säilytetään pitkän aikaa tai jos paristot ovat lopussa.
8. Virtanapoihin ei saa aiheuttaa oikosulkuja.

ATTENZION: PER EVITARE PERDITE DALLE PILE:

1. Osservare il diagramma per capire come togliere ed inserire le pile
2. Le pile non ricaricabili non devono mai essere ricaricate.
3. Le pile ricaricabili devono essere tolte dal giocattolo prima di essere ricaricate e devono essere ricaricate sotto la supervisione di un adulto.
4. Non mescolare pile alcaline, normali (zinco carbonio) o ricaricabili (nickel cadmium). Non mescolare pile usate e nuove.
5. Si dovrebbero usare solo pile del tipo raccomandato o di un tipo simile.
6. Le pile devono essere inserite secondo la giusta polarità (vedi diagramma).
7. Togliere le pile dal giocattolo prima di lunghi periodi di inutilizzazione o se le pile sono scariche.
8. I terminali di alimentazione non devono essere corto-circuitati.

FORSIKTIG: SLIK UNGNÅG DU BATTERILEKKASJE:

1. Illustrasjonen viser hvordan du skal ta ut og sette inn batteriene.
2. Batterier som ikke er oppladbare, skal aldri lades opp på nytt.
3. Oppladbare batterier må tas ut av leketøyet før de lades opp igjen, og oppladning må skje under oppsyn av en voksen.
4. Alkaliske, standard og oppladbare batterier (nikkelkadmium) skal ikke brukes om hverandre. Nye og gamle batterier skal heller ikke brukes sammen.
5. Bruk kun batterier av anbefalt type eller en tilsvarende type.
6. Batteriene skal settes inn slik at polene vender riktig vei.
7. Ta batteriene ut av leketøyet ved lengre tids oppbevaring og når de er oppbrukt.
8. De elektriske polene må ikke kortsluttes.

ATENÇÃO: PARA EVITAR O ESCORRIMENTO DAS BATERIAS:

1. Consulte o diagrama sobre a inserção das baterias.
2. As baterias não recarregáveis nunca devem ser recarregadas.
3. As baterias recarregáveis devem ser removidas do brinquedo antes de serem recarregadas. O recarregamento de baterias sempre deve ser supervisionado por um adulto.
4. Não misture baterias alcalinas normais (zinco de carbono) com recarregáveis (níquel cádmio). Não combine baterias novas com usadas.
5. Utilizar só baterias do tipo recomendado ou semelhantes.
6. As baterias devem ser inseridas de acordo com a polaridade indicada (veja o diagrama).
7. Remova as baterias do brinquedo ao armazená-lo por um período prolongado ou se as baterias estiverem gastas.
8. Os terminais de alimentação não devem ser ligados em curto circuito.

VAR FÖRSIKTIG: UNDVIK BATTERILÄCKAGE:

1. I diagrammet visas hur batterierna ska bytas ut.
2. Ladda aldrig batterier som inte är avsedda för att återladdas.
3. Laddningsbara batterier måste avlägsnas från leksaken innan de laddas och laddningsbara batterier måste laddas under övervakning av vuxen.
4. Blanda inte alkaliska, standard (kolzink) och laddningsbara (nikkelkadmium) batterier. Blanda inte ihop använda och nya batterier.
5. Endast batterier av rekommenderad typ eller liknande bör användas.
6. Batterier måste föras in med polerna i rätt läge (se diagrammet).
7. Avlägsna batterierna från leksaken när den ska förvaras under längre tid eller om batterierna är urladdade.
8. Ström till förselterminalerna måste kortslutas.

注意：電気洩れを防ぐために：

1. 電池の取外し及び挿入については、ダイアグラムをご覧ください。
2. 非再充電式電池へ充電しないで下さい。
3. 再充電を行なう場合には再充電式電池をおもちゃから取り外し、再充電式電池の取扱いは大人が行なって下さい。
4. アルカリ、標準（炭素-亜鉛）、あるいは再充電式（ニッケルカドミウム）を混合しないで下さい。古い電池と新しい電池を混合して使用しないで下さい。
5. 推奨タイプ、もしくは同等タイプの電池のみを使用して下さい。
6. 電池は正しい電極に挿入して下さい（ダイアグラムを参照下さい）。
7. おもちゃを長時間使用しない時には、電池を取り外しておいて下さい、そのままにしておくと電池が消耗します。
8. 供給ターミナルは短絡してはいけません。

警告：避免電池洩漏：

1. 參看附圖，了解如何裝卸電池。
2. 非充電電池不能充電。
3. 充電之前必須先把充電電池從玩具里取出來，電池從玩具里取出來，充電過程必須由成人監督。
4. 不要將鹼性電池、標準電池（碳-鋅電池）或充電電池（鎳鎘電池）混在一起使用。不要把新舊電池混在一起使用。
5. 只應當使用我們推薦的電池或者類似型號的電池。
6. 電池必須按正確的極性裝入玩具里。（見附圖）
7. 如果一段時間不用玩具，請取出玩具里的電池，否則電池會消耗干。
8. 電源的两極不能短路。

AB

- تنبيه: لتجنب ارتشاح البطارية:
- 1- انظر إلى الرسم لتعرف كيفية نزع وتركيب البطارية.
 - 2- يجب الامتناع تماما عن شحن البطاريات غير القابلة للشحن.
 - 3- يجب نزع البطارية القابلة للشحن من اللعبة قبل إعادة شحنها. يجب إعادة شحن البطارية القابلة للشحن تحت إشراف شخص بالغ.
 - 4- المستعملة مع البطاريات الجديدة. لا تخلط البطاريات القلوية مع البطاريات التقليدية (زنك الكربون) أو القابلة للشحن (الفلزية المعدنية). لا تخلط البطاريات.
 - 5- يجب استخدام البطاريات من النوع الصحيح به أو من نوع مماثل دون غيرها.
 - 6- يجب إدخال البطارية وفق الطريقة السليمة للسالب والموجب (انظر الرسم).
 - 7- إنزع البطارية من اللعبة عند تركها فترة أطول من اللازم أو عند استهلاك البطارية.
 - 8- يجب ألا تكون الوصلة الكهربائية في دائرة قصيرة.

IF YOU HAVE A PROBLEM, PLEASE DO NOT TAKE THIS TOY BACK TO THE STORE. CONTACT US
EN CASO DE PROBLEMAS, NO DEVUELVA EL PRODUCTO A LA TIENDA DONDE LO COMPRÓ. CONTACTÉENOS
VOUS AVEZ DES PROBLÈMES? ON VOUS PRIERAIT DE NE PAS RETOURNER CE JOUET AU MAGASIN. CONTACTEZ-NOUS
PROBLEME? BRINGEN SIE DAS SPIELZEUG NICHT INS GESCHÄFT ZURÜCK. SETZEN SIE SICH ONLINE MIT UNS IN VERBINDUNG
HEEFT U PROBLEEM? BRENG HET SPEELGOED DAN NIET TERUG NAAR DE WINKEL. NEEM CONTACT MET ONS OP
SI AVETE UN PROBLEMA CON QUESTO GIOCATTOLO, CORTESIA DI NON RIPORTARLO AL NEGOZIO. METTERSI IN CONTATTO CON NOI.
SE TIVER ALGUM PROBLEMA, É FAVOR NÃO DEVOLOVER O BRINQUEDO À LOJA, MAS ENTRAR EM CONTATO CONOSCO.

1-800-465-MEGA

U.S. & Canada only / Solamente en EEUU y Canadá / É.U. et Canada seulement / Nur für U.S & Kanada /

Uitsluitend in de V.S. en Canada / USA e Canada solamente / Somente EE.UU. e Canadá

WWW.MEGABRANDS.COM



suggested storage position / posición recomendada
para el almacenamiento del producto / position de
rangement conseillée / empfohlene Aufbewahrung /
aanbevolen manier van opbergen / posizione consigliata
nei periodi di mancato utilizzo / posição sugerida para
armazenamento

*With the exception of electronic / mechanical parts.

*A excepción de los elementos eléctricos / mecánicos.

*À l'exception des éléments électroniques / mécaniques.

*Mit Ausnahme der elektronischen / mechanischen Teile.

*Met uitzondering van de elektronische / mechanische onderdelen.

*Con l'eccezione di parti elettroniche / meccaniche.

*Com excepção de peças eletrônicas/meccânicas.

**LIFETIME GUARANTEE*/GARANTIZADO
DE POR VIDA*/GARANTIE À VIE*
LEBENS-LANGE GARANTIE*/LEVENSLANGE
GARANTIE*/GARANZIA A VITA*/
TEM GARANTIA VITALÍCIA***

COMMENTS, QUESTIONS ? / ¿ COMENTARIOS, PREGUNTAS ? / COMMENTAIRES,
QUESTIONS ? / KOMMENTARE, FRAGEN ? / COMMENTAAR, VRAGEN ?
COMMENTI?, DOMANDE? / PERGUNTAS?, COMENTÁRIOS?

1-800-465-MEGA

U.S. & Canada only / Solamente en EEUU y Canadá / É.U. et Canada
seulement / Nur für U.S und Kanada / Uitsluitend in de V.S. en Canada /
USA e Canada solamente / Somente EE.UU. e Canadá

www.megabrand.com

**MEGA
BLOKS**

**NEO
SHIFTERS**
The Power² Change[®]

web code / Code Web /
Código web / Web-Kode /
Codice Web / Código Web



WWW.NEOSHIFTERS.COM

MEGA

© 2007, MEGA Brands Inc. ® and ™ denote trademarks of MEGA Brands Inc. This toy conforms to: Voluntary Product Standard F963 U.S., Canadian Hazardous Products Act, CEN Standards E.N. 71. Products and colors may vary. ® and ™ designan la marca registrada y la marca comercial de MEGA Brands Inc. Este juguete es de conformidad con: Voluntary Product Standard F963 U.S., Canadian Hazardous Products Act, CEN Standards E.N. 71. Las piezas y los colores pueden variar. ® et ™ désignent des marques de commerce de MEGA Brands Inc. Ce jouet est conforme aux: Voluntary Product Standard F963 U.S., Canadian Hazardous Products Act, CEN Standards E.N. 71. Les items et les couleurs peuvent varier. ® et ™ sind Markenzeichen der Firma MEGA Brands Inc. Dieses Spielzeug stimmt mit: Voluntary Product Standard F963 U.S., Canadian Hazardous Products Act, CEN Standards E.N. 71 überein. Produkte und Farben können unterschiedlich sein. ® en ™ duiden op handelsmerken van MEGA Brands Inc. Dit speelgoed voldoet aan: Voluntary Product Standard F963 U.S., Canadian Hazardous Products Act, CEN Standards E.N. 71. In producten en kleuren kan variatie optreden. ® e ™ indicano dei marchi depositato di MEGA Brands Inc. Questo giocattolo è conforme a: Voluntary Product Standard F963 U.S., Canadian Hazardous Products Act, CEN Standards E.N. 71. Prodotti e colori possono variare. ® e ™ denotam marcas registradas de MEGA Brands Inc. Este brinquedo conforma-se ao Produto Padrão Voluntário F963 EE.UU., Decreto Canadense de Produtos Perigosos, Padrões CEN, E.N. 71. Produtos e cores podem variar.
Printed in China AD063031

JOIN THE RESISTANCE

